

Typ S-APZ 1, S-EPZ 1

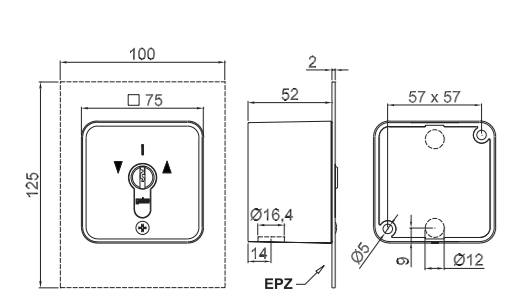

Schalteinsatz ES 2T (R)/2

Typ J-APZ 1, J-EPZ 1

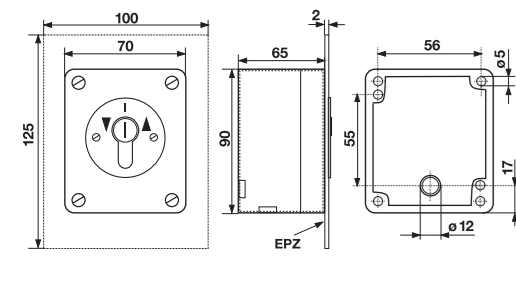

Schalteinsatz J-1T/1, J-2T/1, J-2T/2, J-1R/2, J-2R/2, J-1TR/2, J-2T/2W, S 32

Typ MS-APZ 1

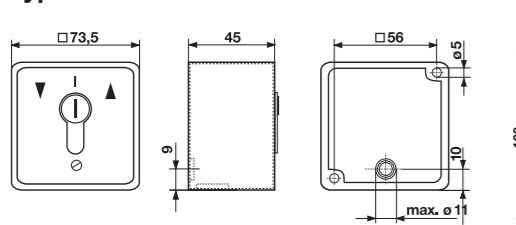

Schalteinsatz M-1T/1 (NO), M-1T/1 (NC)

Typ M-APZ 1

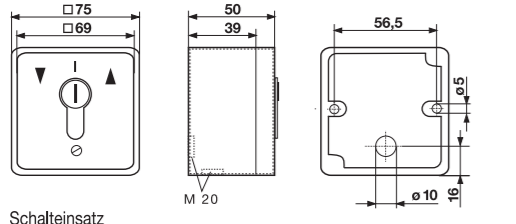

Schalteinsatz M-1T/1 (NO), M-1T/1 (NC)

Typ MR 1

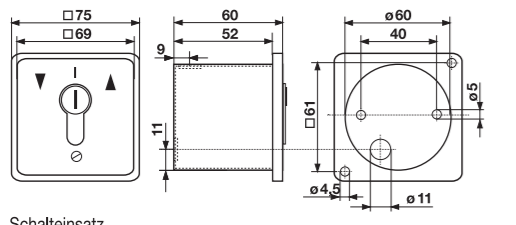

Schalteinsatz M-1T/1 (NO), M-1T/1 (NC)

Typ MSR 1

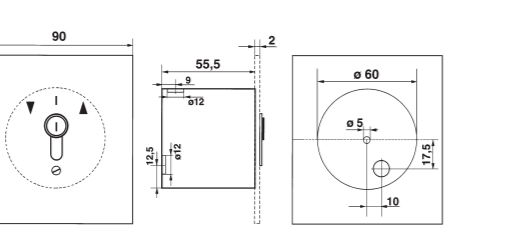

Schalteinsatz M-1 T/1 (NO), M-1 T/1 (NC)

Typ MP-APZ 1, MP-EPZ 1

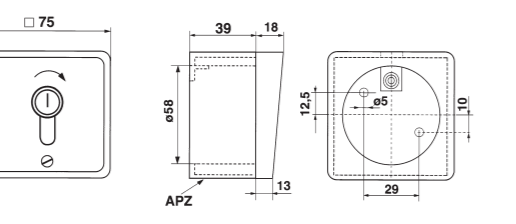

Schalteinsatz M-1 T/1 (NO), M-1 T/1 (NC)

Typ MP-ARZ 1, MP-ERZ 1

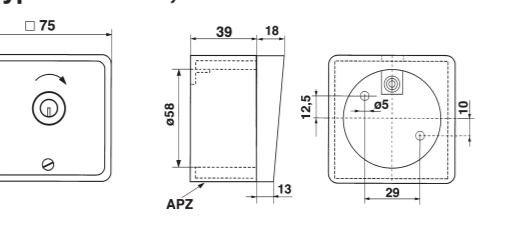

Schalteinsatz M-1 T/1 (NO), M-1 T/1 (NC)

Typ J-KU 1

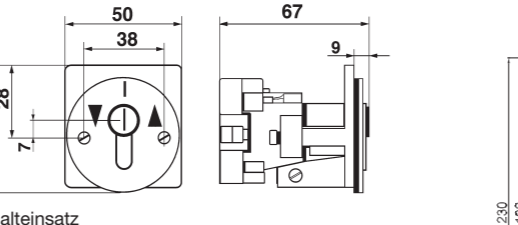

Schalteinsatz J-1T/1, J-2T/1, J-2T/2, J-1R/2, J-2R/2, J-1TR/2, J-2T/2W, S 32

Typ S-APZ 2, S-EPZ 2

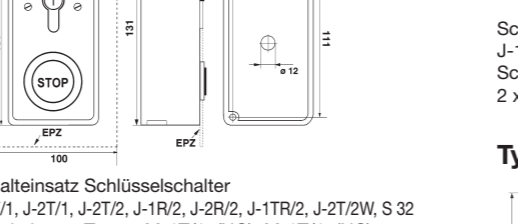

Schalteinsatz Schlüsselschalter J-1T/1, J-1T/2, J-1R/2
Schalteinsatz Taster 2 x M-1T/1 (NO), 2 x M-1T/1 (NC)

Typ J-APZ 2, J-EPZ 2

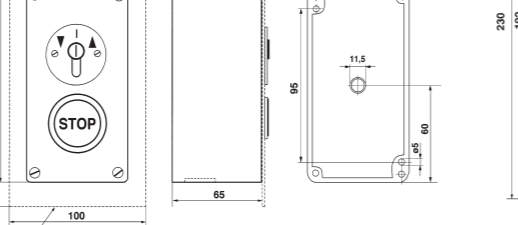

Schalteinsatz Schlüsselschalter J-1T/1, J-1T/2, J-2T/1, J-2T/2, J-1R/2
Schalteinsatz Taster M-1T/1 (NO), M-1T/1 (NC)

Typ J-APZ 3, J-EPZ 3

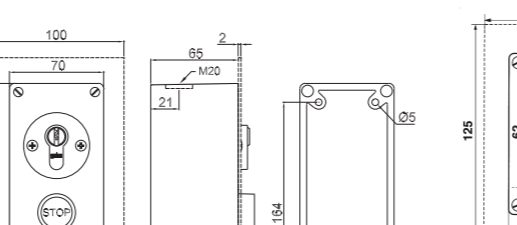

Schalteinsatz Schlüsselschalter J-1T/1, J-1T/2, J-1R/2
Schalteinsatz Taster 2 x M-1T/1 (NO), 2 x M-1T/1 (NC)

Typ J-APZ 4, J-EPZ 4

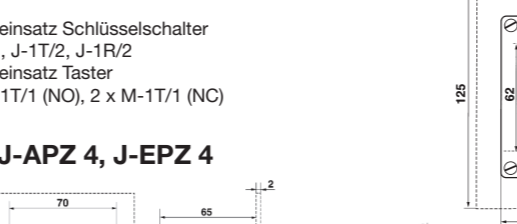

Schalteinsatz Schlüsselschalter J-1R/2
Schalteinsatz Taster 2 x M-1T/1 (NO), 3 x M-1T/1 (NC)

Typ GDT 1, GDT E 1

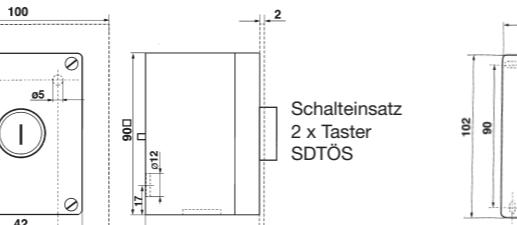

Schalteinsatz 2 x Taster SDTÖS

Typ GDT 2, GDT E 2

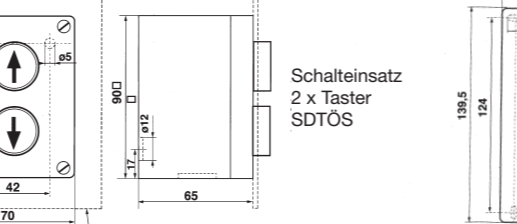

Schalteinsatz 2 x Taster SDTÖS

Typ GDT 3, GDT E 3

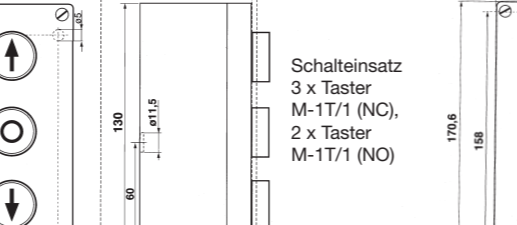

Schalteinsatz 3 x Taster M-1T/1 (NC), 2 x Taster M-1T/1 (NO)

Typ KDT 2 / KDT 2 C

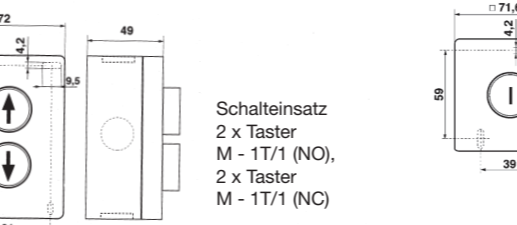

Schalteinsatz 2 x Taster M-1T/1 (NO), 2 x Taster M-1T/1 (NC)

Typ KDT 3 / KDT 3 C

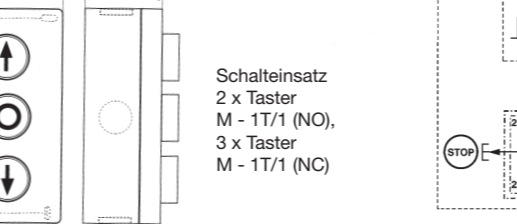

Schalteinsatz 2 x Taster M-1T/1 (NO), 3 x Taster M-1T/1 (NC)

Typ KDT 4



Schalteinsatz 4 x Taster SDTÖS

Typ KDT 1



Schalteinsatz 1 x Taster M1T/1 (NO), (KDT 1N M1T/1 (NC))

Anschlußbilder J-APZ..., J-EPZ...

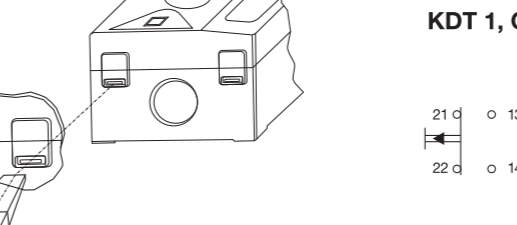

* optional

4-1R 3-1R 3-1T

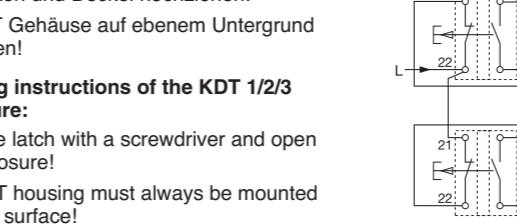

* optional

Anschlußbilder KDT, GDT

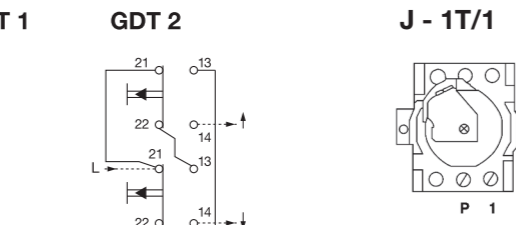

KDT 2 KDT 3, GDT 3

KDT 4

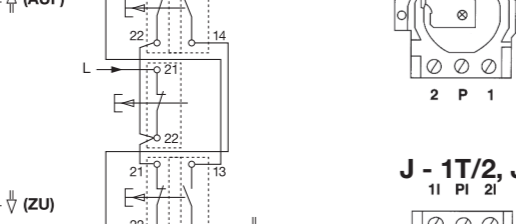

Schalteinsätze J

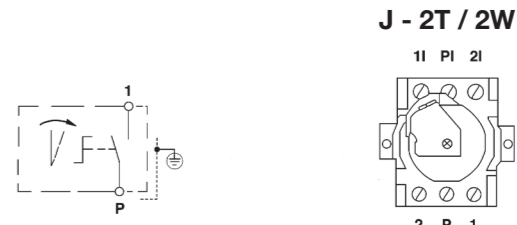

J - 1T/1

J - 2T/1

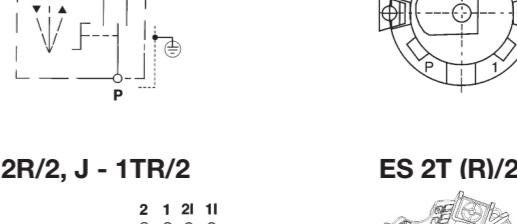

J - 2T/1

J - 1T/2, J - 2R/2, J - 1TR/2

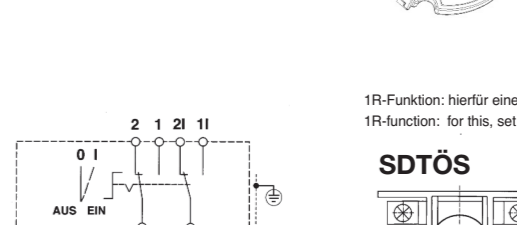

J - 1T/2, J - 2R/2, J - 1TR/2

J - 1R/2



J - 1R/2

Schalteinsätze J, S, ES, SDT

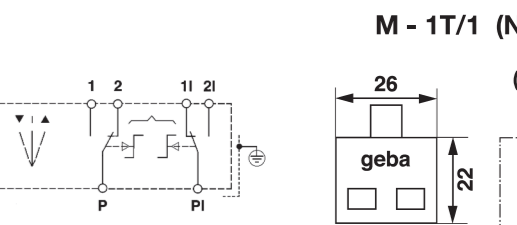

J - 2T / 2W

S 32

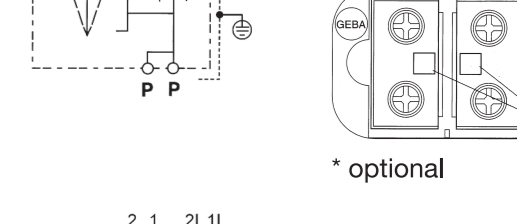

S 32

ES 2T (R)/2

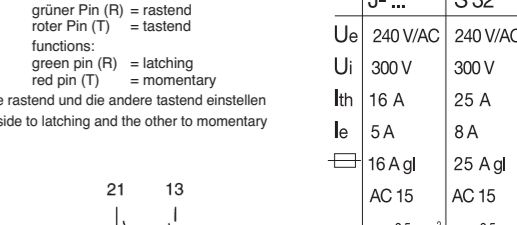

ES 2T (R)/2

SDTÖS



SDTÖS

Schalteinsätze M

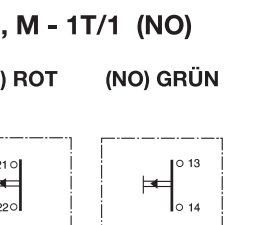

M - 1T/1 (NC), M - 1T/1 (NO)

STOP - Taster, Schalter

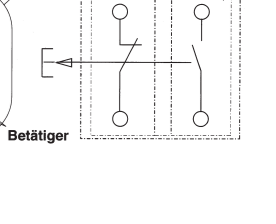

J-APZ 2, J-EPZ 2, J-APZ 3, J-EPZ 3, GDT 3

Données techniques, Technische Gegevens, Technische Daten, Datos técnicos, Technical Data

	J-...	S 32	SDTÖS	M-...	ES
U _e	240 V/AC	240 V/AC	240 V/AC	240 V/AC	240 V/AC
U _i	300 V	300 V	300 V	300 V	300 V
I _{th}	16 A	25 A	10 A	16 A	16 A
I _e	5 A	8 A	3 A	5 A	5 A
	16 A gl	25 A gl	10 A gl	16 A gl	16 A gl
	AC 15	AC 15	AC 15	AC 15	AC 15
	max.2,5 mm ²	max.2,5 mm ²	max.2,5 mm ²	max.1,5 mm ²	max.1,5 mm ²
	30 T 50	30 T 50	30 T 50	30 T 50	30 T 50